

# Round Green Through-hole LED Lamp (3mm)

## OVLBG4C7

- High Brightness with Well-defined Spatial Radiation Patterns
- UV-resistant Epoxy Lens
- Green (525nm)

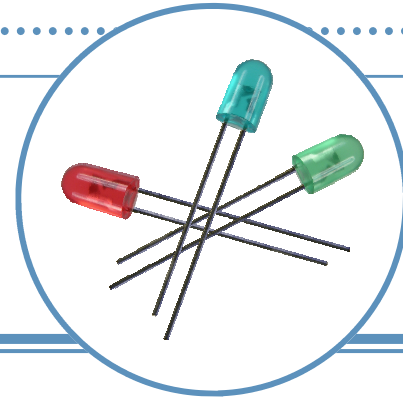

The OVLBG4C7 is a high-intensity InGaN LED mounted in a clear plastic T-1 package. Its UV-resistant epoxy lens makes this device an optimal solution for outdoor applications. This LED provides a well-defined and even emission pattern.

## Applications

- Pedestrian Signals
- Signage and Architectural Lighting
- Backlighting
- Automotive
- Outdoor/Indoor Displays

Part Number	Material	Emitted Color	Intensity Typ. mcd	Lens Color
OVLBG4C7	InGaN	Green	2000	Water Clear

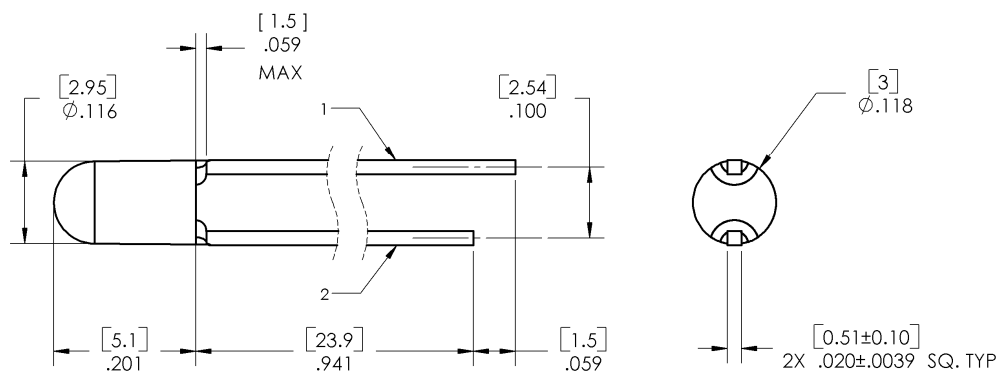

1 ANODE 2 CATHODE DIMENSIONS ARE IN INCHES AND [MILLIMETERS].

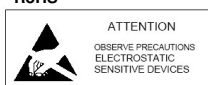

OPTEK reserves the right to make changes at any time in order to improve design and to supply the best product possible.

# Round Green Through-hole LED (3mm) OVLBG4C7



## Absolute Maximum Ratings

T<sub>A</sub> = 25°C unless otherwise noted

Storage Temperature Range	-40 ~ +100°C
Operating Temperature Range	-40 ~ +85°C
Reverse Voltage	5 V
Continuous Forward Current	20 mA
Peak Forward Current (10% Duty Cycle, 1KHz)	50 mA
Power Dissipation	80 mW
Current Linearity vs. Ambient Temperature	-0.2 mA/°C
LED Junction Temperature	125°C
Lead Soldering Temperature (3mm from the base of the epoxy bulb) <sup>1</sup>	260°C

Note:

- Solder time less than 5 seconds at temperature extreme.

## Electrical Characteristics

T<sub>A</sub> = 25°C unless otherwise noted

SYMBOL	PARAMETER	MIN	TYP	MAX	UNITS	CONDITIONS
I <sub>V</sub>	Luminous Intensity	1285	2000	----	mcd	I <sub>F</sub> = 20mA
V <sub>F</sub>	Forward Voltage	----	3.4	4.0	V	I <sub>F</sub> = 20mA
I <sub>R</sub>	Reverse Current	----	----	50	μA	V <sub>R</sub> = 5V
λ <sub>P</sub>	Peak Wavelength	----	521	----	nm	I <sub>F</sub> = 20mA
λ <sub>D</sub>	Dominant Wavelength	519	525	531	nm	I <sub>F</sub> = 20mA
2Θ <sub>1/2</sub> H-H	50% Power Angle	----	45	----	deg	I <sub>F</sub> = 20mA

## Standard Bins (I<sub>F</sub> = 20mA)

Lamps are sorted to luminous intensity (I<sub>V</sub>) and dominant wavelength (λ<sub>D</sub>) bins shown. Orders for OVLBG4C7 may be filled with any or all bins contained as below.

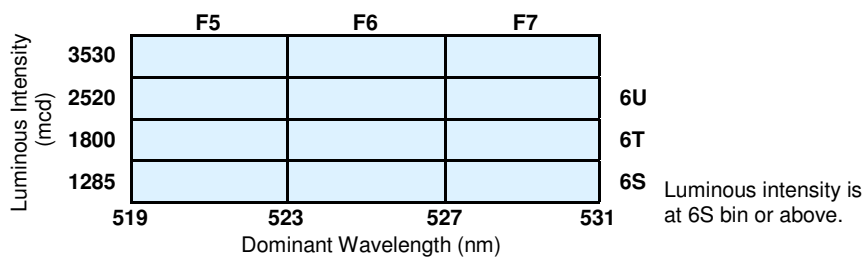

Forward Voltage

Rank	H	J	K	L
Voltage	2.6–3.0	3.0–3.3	3.3–3.6	3.6–4.0

### Important Notes:

- All ranks will be included per delivery, rank ratio will be based on the chip distribution.
- To designate luminous intensity ranks, please contact OPTEK.
- Pb content <1000PPM.

## Beam Pattern

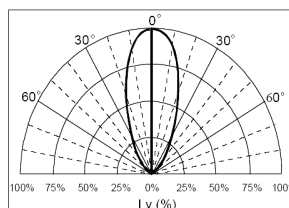

## Typical Electro-Optical Characteristics Curves

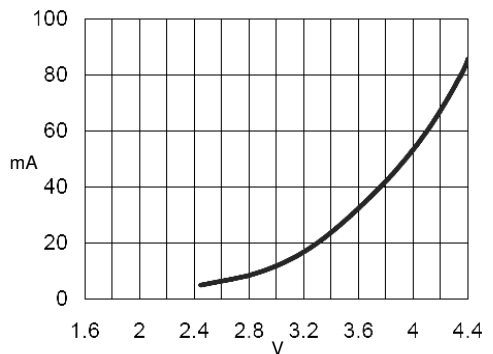

Forward Current vs. Forward Voltage

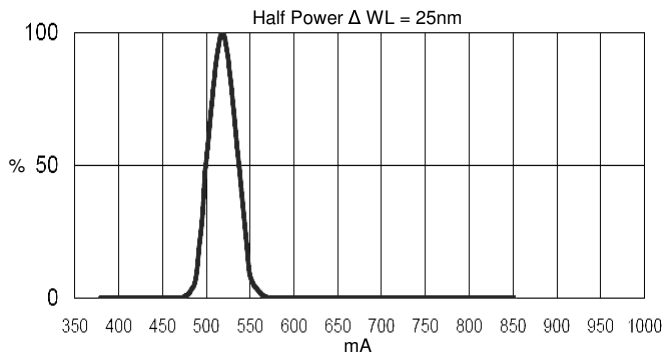

Relative Luminous Intensity vs. Wavelength

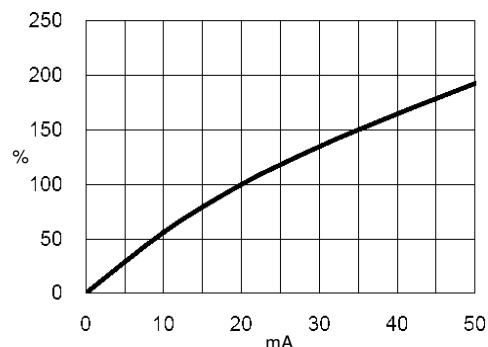

Relative Luminous Intensity vs. Forward Current

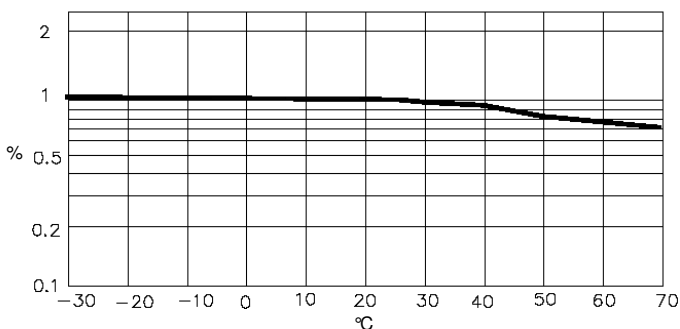

Relative Luminous Intensity vs. Ambient Temperature

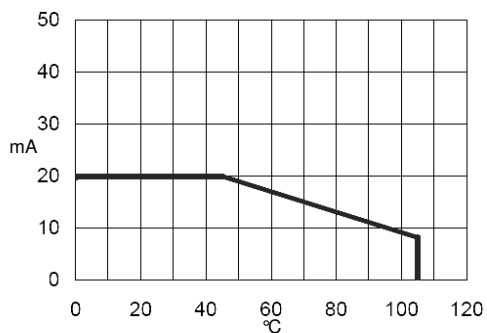

Forward Current vs. Ambient Temperature

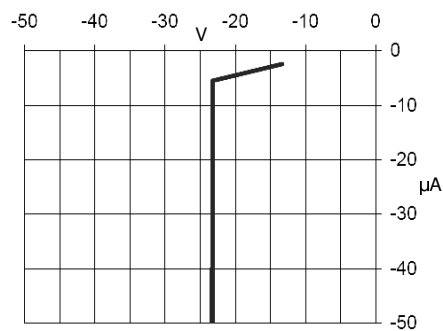

Reverse Current vs. Reverse Voltage

# Round Green Through-hole LED (3mm) OVLBG4C7

Packing Information: Available in Bulk or Reel

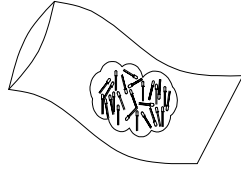

Bulk: 500 pcs/bag

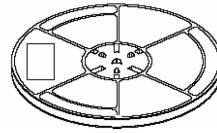

13-Inch Reel: 2500 pcs/reel

Carrier Tape Dimensions: Loaded Quantity 2500 PCS per Reel

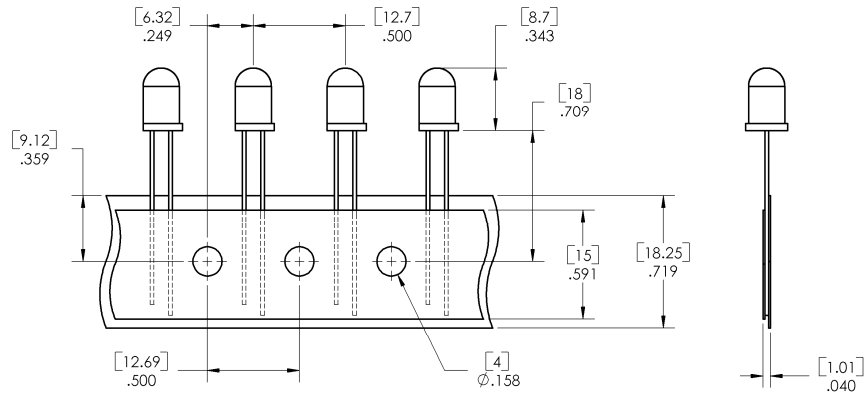

DIMENSIONS ARE IN INCHES AND [MILLIMETERS].

Moisture Resistant Packaging

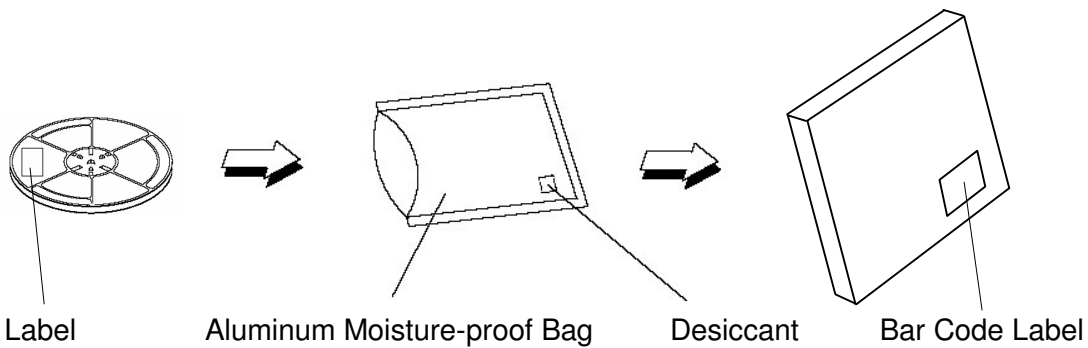

Round Green Through-hole LED (3mm)  
OVLBG4C7



Issue	Change Description	Approval	Date
1.0	Initial Release	J. Haynie	7/28/05